

# WiFi Module USER'S MANUAL

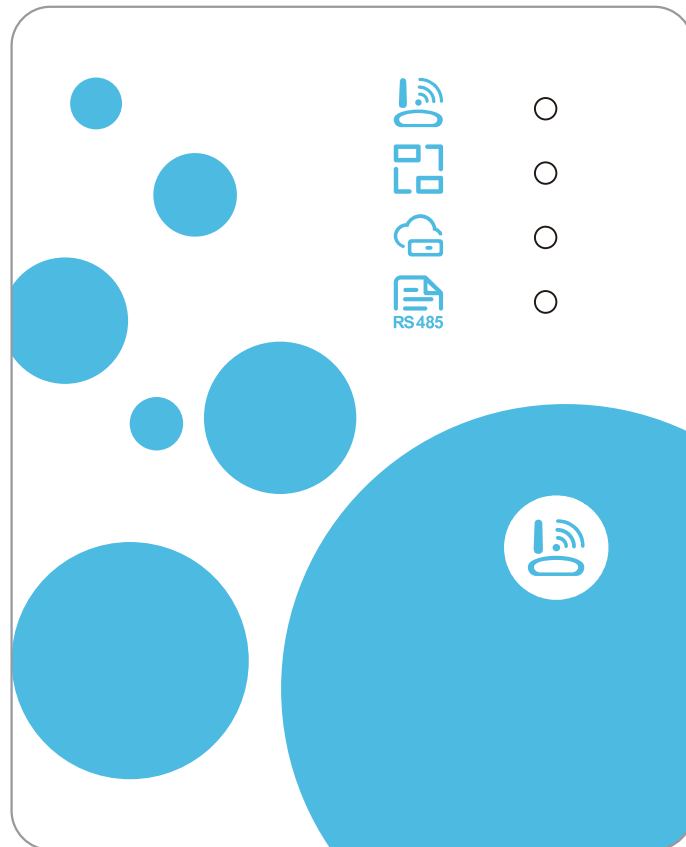

Please read this user's manual carefully before starting  
Please keep this user's manual properly

# User Privacy Instructions

---

We take your privacy very seriously and we promise to inform you how we use the data. Users' private data, such as mailboxes, address, before uploading to the cloud, we will get your permission, and we will work hard to protect your data security.

## Description

---

- Receive data signal from cloud server and transmit to the main device;
- Receive data signal from main device and transmit to cloud server;
- To achieve remote upgrade the WiFi module baseplate MCU by cloud server;
- To achieve the remote upgrade of the main device by WiFi module baseplate MCU.

## Technical Parameters

---

OPERATING VOLTAGE: DC8V~12V (Recommended value 12V)

OPERATING CURRENT: Max. recurrent peak 1A, average standby current 50mA

TEMP. RANGE: Operating Temp.: -30°C~+70°C; Storage Temp.: -40°C~+85°C

LED INDICATOR LIGHT:

4 lights, Network configuration indicator, router connection indicator, cloud server connection indicator, 485 communication indicator;

DIMENSION(L×W×H): 78mm×63mm×24mm

## Installation

---

- There is a magnet on the back of the WiFi module, it can be installed indoors or outdoors, and avoid direct sunlight;

# Functional Description

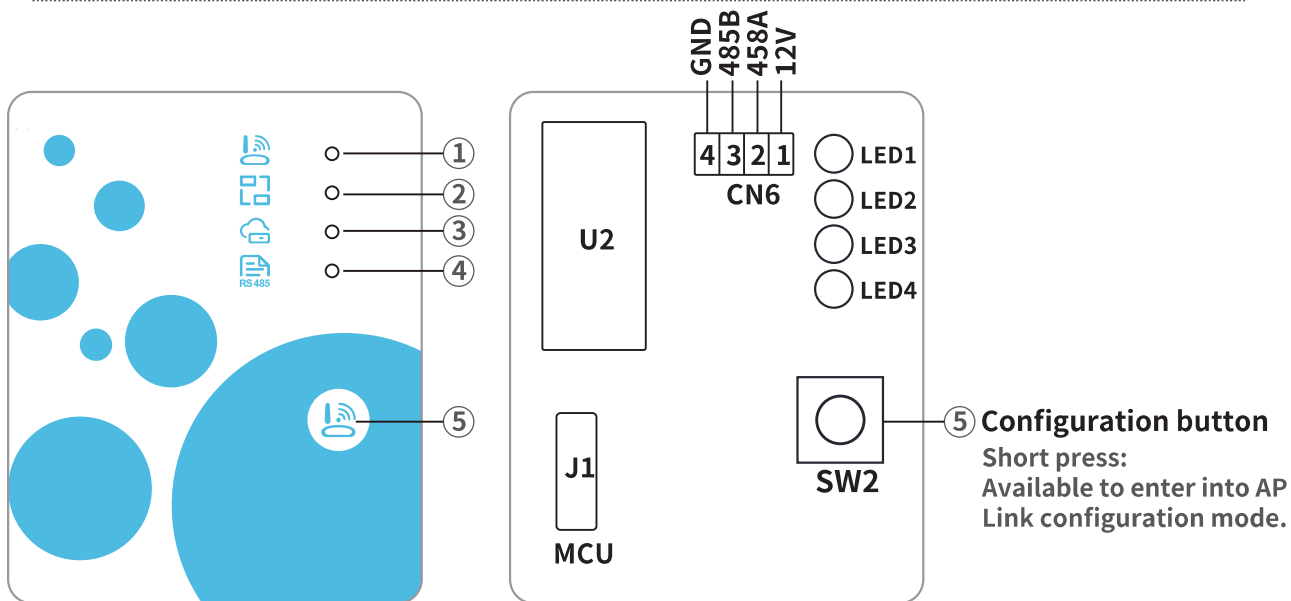

ITEM	NAME	LONG LIGHT	SLOW FLASH	EXTINGUISH
①	Network configuration indicator	Configuring Network	SmartLink configuring	Done
②	Router connection indicator	Normal	Abnormal	----
③	Cloud server connection indicator	Normal	Abnormal	----
④	485 communication indicator	Normal	Abnormal	----

# Account Login

Use email address and password to register, login or reset the password.

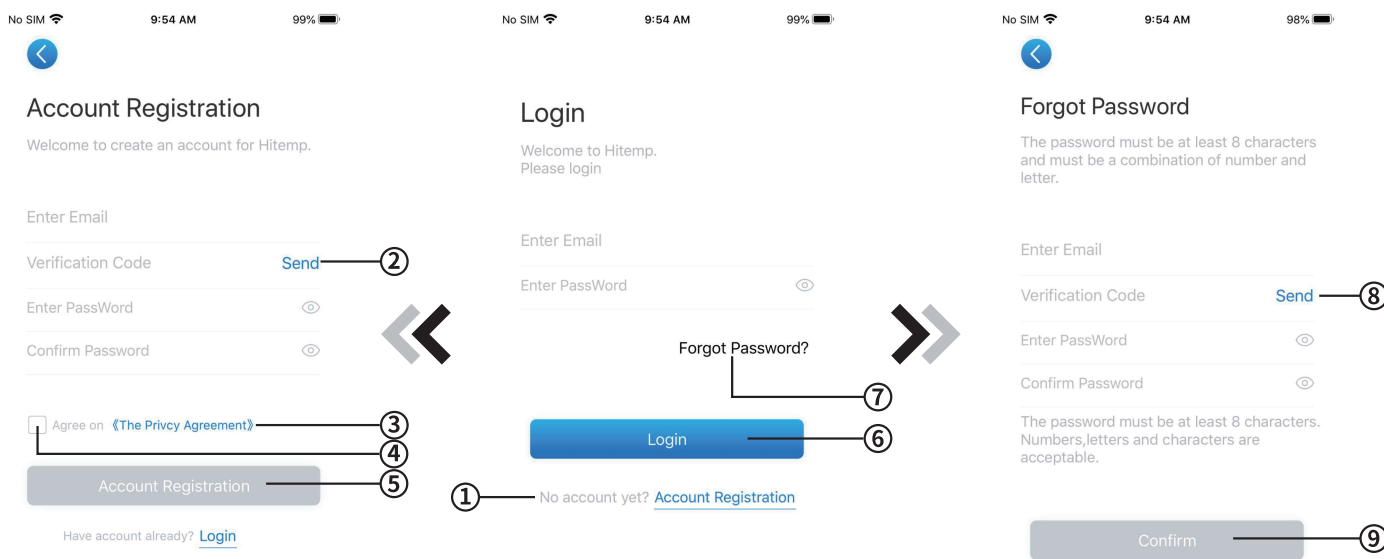

Fig.2 Account Registration interface

Fig.1 Login interface

Fig.3 Forgot Password interface

1. Account Registration: To register an account, click ① (Fig.1) to jump to the Account Registration interface, fill in the relevant information and click ② to receive verification code, while completed the application information, click ③ to read the details of the Privacy Policy, then click ④ to agree, and click ⑤, registration is done.

Please note, the valid time of one verification code is 15min, please fill in the verification code within 15min, otherwise you need to ask for a new one.

2. Log in: Follow the instructions on the page(Fig.1 ), enter your registered email address and password, click ⑥ and jump to device list;

3. Forgot Password: While forget your password, click ⑦ (Fig.1 ), jump to the Forgot Password interface (Fig.3 ). Follow the instructions on the page, fill in the relevant informations, click ⑧ to receive verification code from your mailbox, click ⑨ to confirm and password reset is done.

## Add Device

After login, displays My Device interface (Fig. 4) , follow the instruction to add WiFi or DTU.

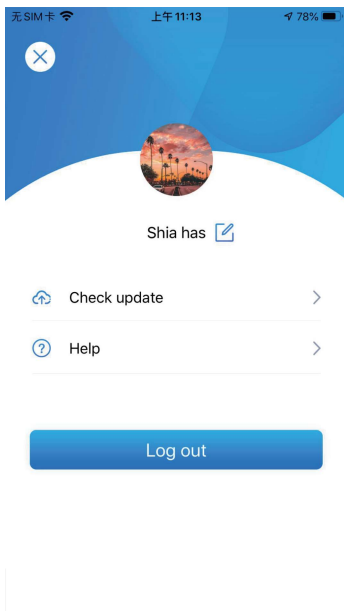

Fig.5 The left-hand menu

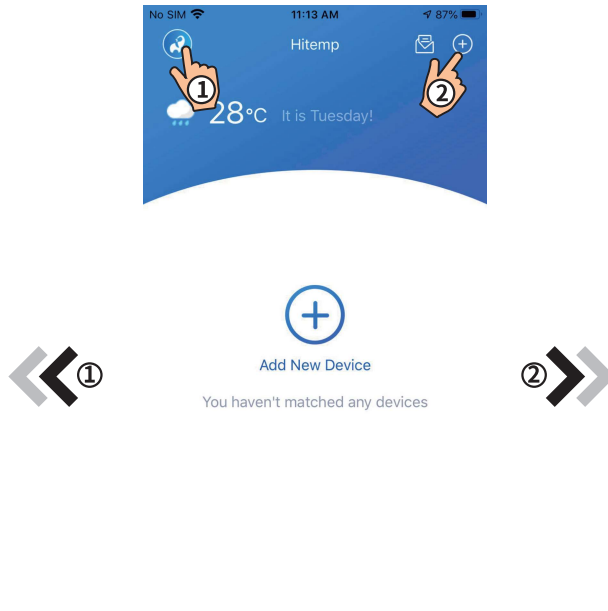

Fig.4 My Device interface

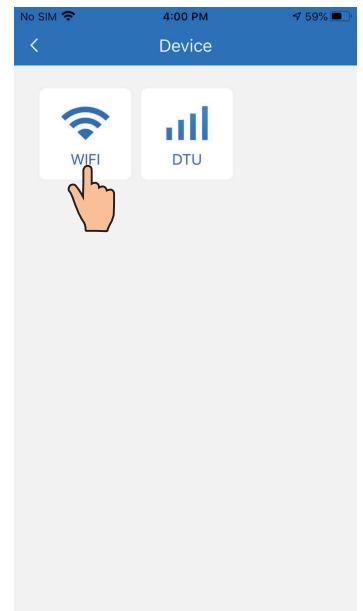
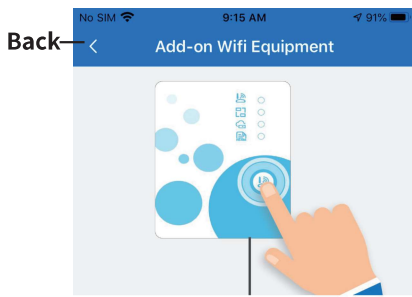

Fig.6 Add Device interface

# WiFi Configure Network



Press button on module and hold for 1s till two lights on, then AP connection is activated

10 Confirm Operation Completed

11 Next

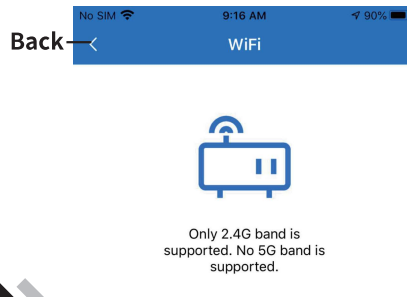

Only 2.4G band is supported. No 5G band is supported.

Private  
Enter PassWord

12

Next 13

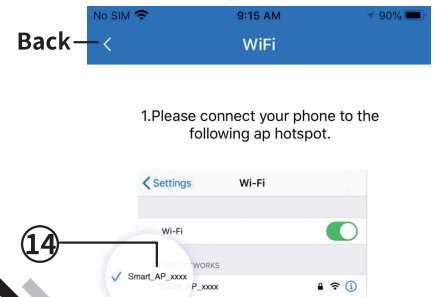

1. Please connect your phone to the following ap hotspot.

14



2. Return to the application and continue adding device.

15 Wi-Fi Setting

Fig.7 WiFi Module On interface

Fig.8 Enter password interface

Fig.9 Connect specified WiFi

1. Follow the instructions on the page (Fig.7), press button on module and hold for 1s till two lights on, then AP connection is activated, click 10 to confirm, click 11 to turn the page;
2. Click 12 to enter the WiFi password for the current connection, click 13 to confirm;
3. Jump to system settings, connect specified WiFi, click 14 to select the "Smart\_AP\_xxx", click 15 to popup window (Fig.10), follow the instruction and then jump to WiFi setting interface (Fig.11);

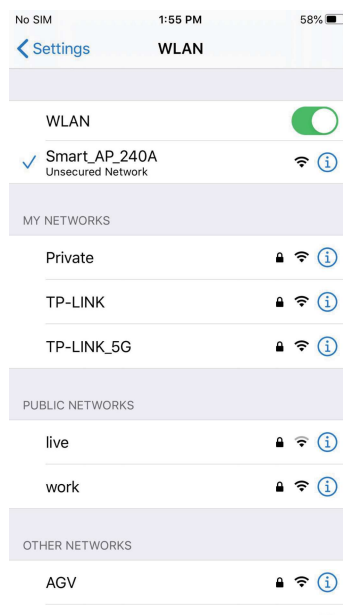
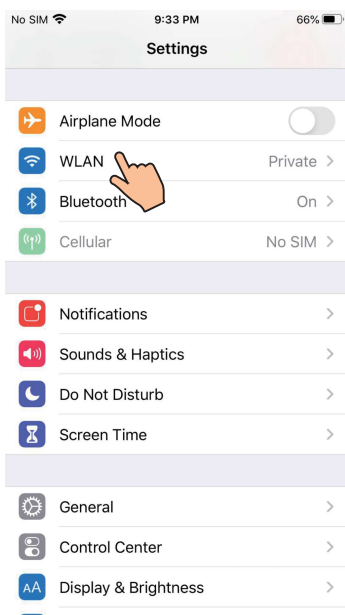

1. Please connect your phone to the following ap hotspot.

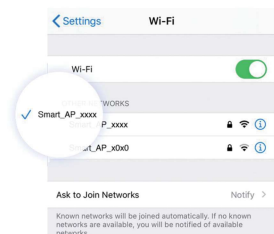

2. Return to the application and continue adding device.

Next 16

Fig.10 Setting interface

Fig.11 WiFi setting interface

Fig.12 Connect specified WiFi

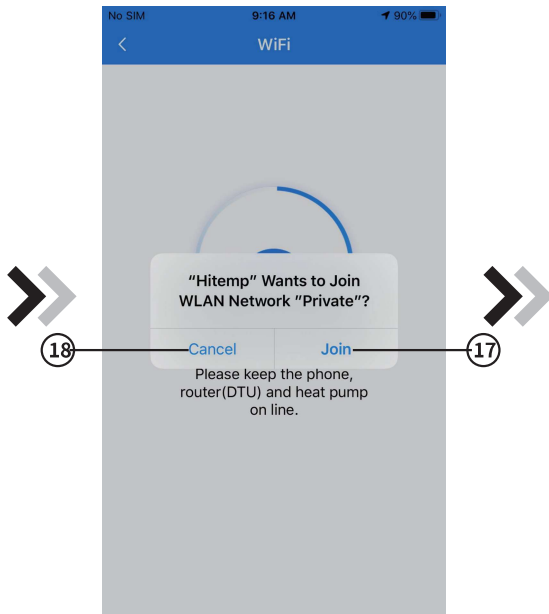

Fig.13 Configure Network interface

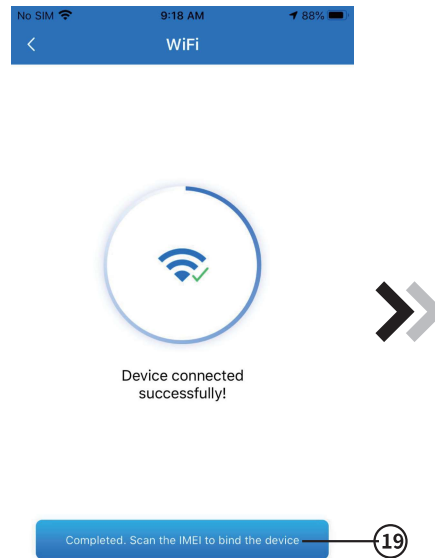

Fig.14 Bond Device interface

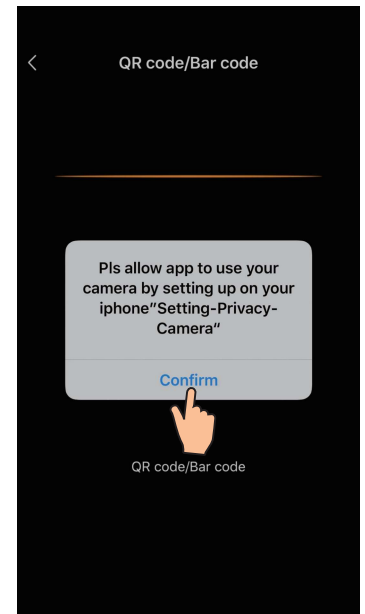

Fig.15 Scanning interface

4. Slide the page back to configure network interface, click ①⑥ to turn next page (Fig. 12), click ①⑦ to join WLAN Network, click ①⑧ to cancel(Fig. 13); click ①⑨ to bond device (Fig. 14);
5. Click "OK" (Fig.15) to allow the App to use the camera for scanning the **Barcode** on the heat pump unit (Fig.16);
6. Click "OK" , device bond is done (Fig.17);
7. After WiFi and DTU bonding is done, and jump back to the main interface of device(Fig. 18).



Fig.16 Barcode

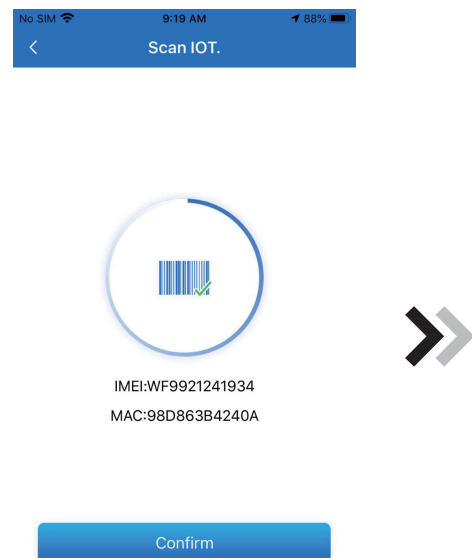
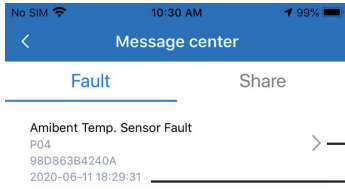

Fig.17 Bond device done interface

# Device Management

Device management operations are as below :



Click to read the solution  
Display the error

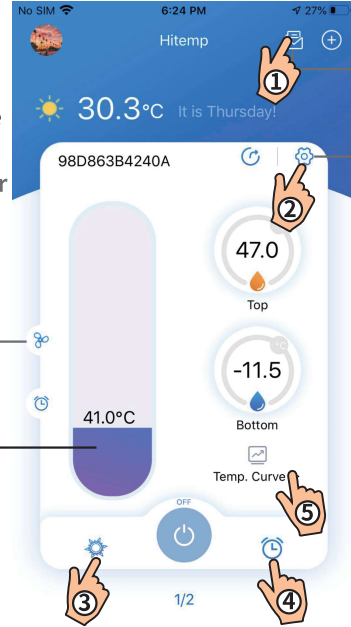

Functions status of the unit  
Click or slide to change the target temperature

Share/  
Faulty message  
Functions setting

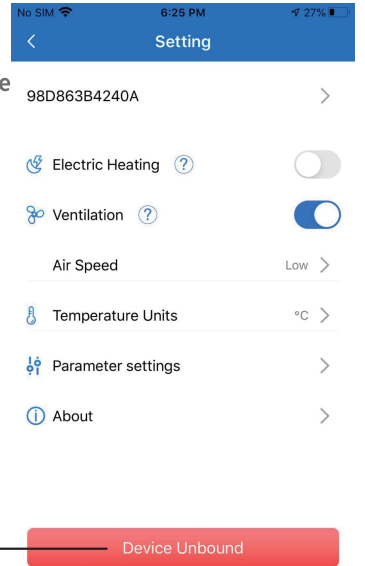

Delete

Fig.19 Troubleshooting interface

Fig.18 Device Main interface

Fig.20 Setting interface

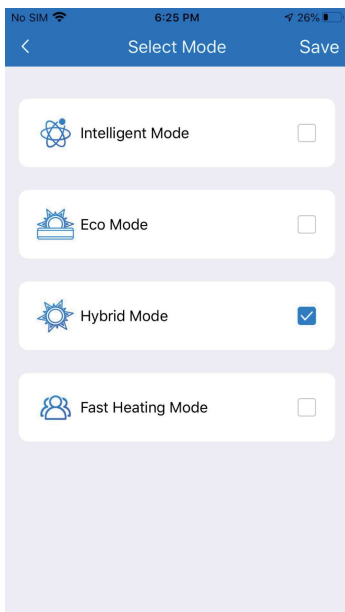

Click to adjust the timer settings

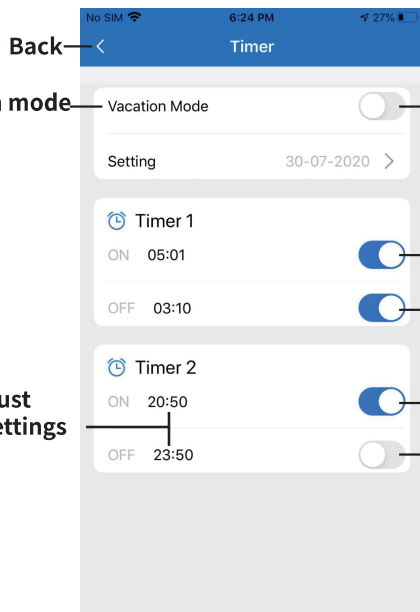

Vacation mode switch

Click to switch ON/ OFF  
ON: Blue  
OFF: Grey

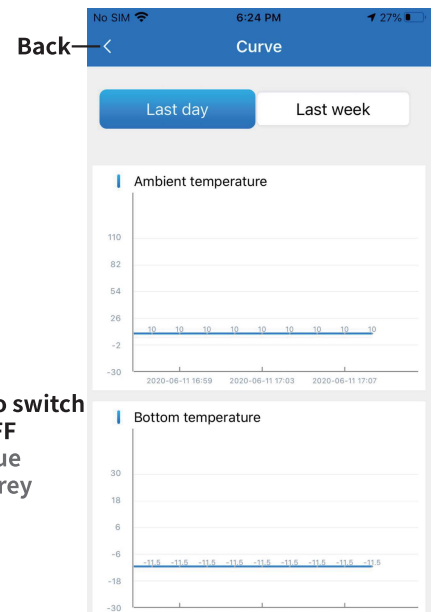











Fig.21 Mode switching interface

Fig.22 Timers settings interface

Fig. 23 Temperature curve

ICON	NAME	FUNCTIONS
	ON/ OFF	Click it to turn on/ off the unit
	Timers settings	Click to enter timer on/off, vacation mode
	Message	Click to check the share/faulty message
	Mode	Mode changing: Intelligent - Eco - Hybrid - Fast Heating
	Intelligent	Select Save to change the working mode
	Eco	Select Save to change the working mode
	Hybrid	Select Save to change the working mode
	Fast Heating	Select Save to change the working mode
	Setting	Click to change the functions setting of unit
	Temperature curve	Display the corresponding temperature graph